



Model: WS RETROFIT V3 FOR C4 T3 7"
VERSION 3 NOTES

Family: WALL-SMART

DWG NO. 10-04-767-V3NOTES

Model No.: 10-01-767-BL-WH

PRODUCT SPEC.

REVISION A

DATE 22/AUG./2017



VERSION 2 (END OF LIFE) SKU: 10-01-580 RETROFIT BASE CONTROL4 T3 7"
10-01-581 RETROFIT BEZEL C4 T3 7" BLACK
10-01-582 RETROFIT BEZEL C4 T3 7" WHITE

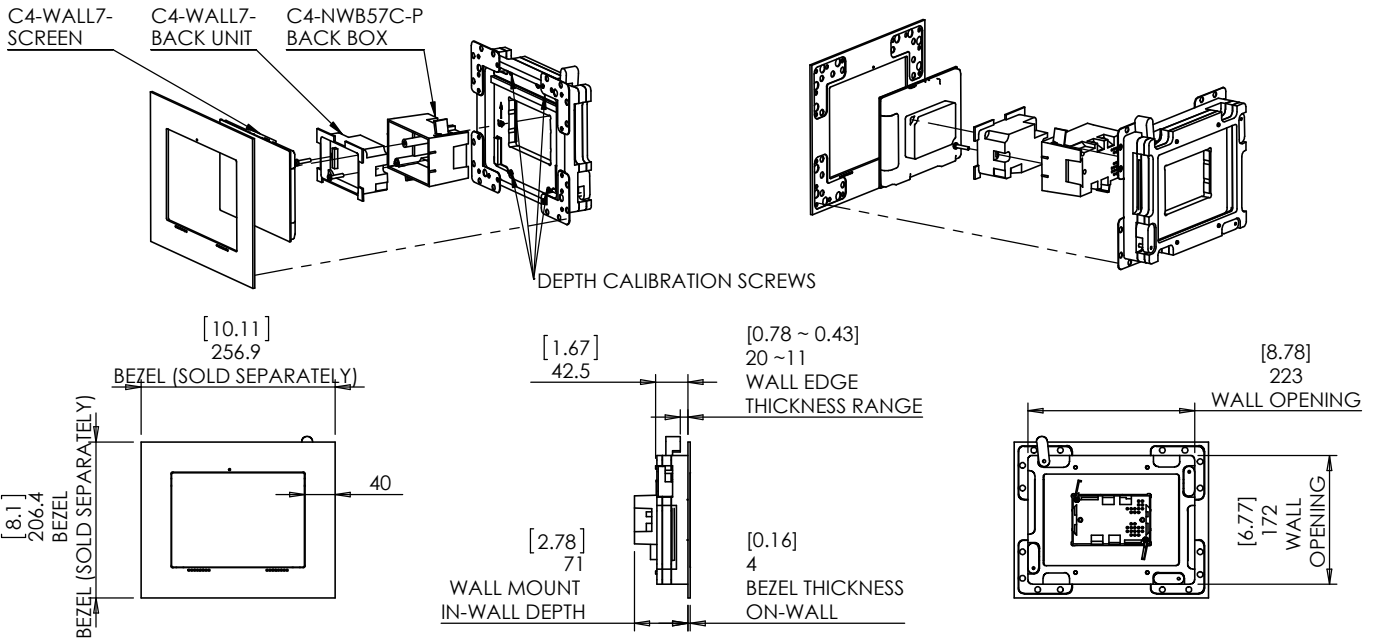

NEW VERSION 3, SKU: 10-01-767-BL WS RETROFIT V3 FOR C4 T3 7" BLACK
10-01-767-WH WS RETROFIT V3 FOR C4 T3 7" WHITE

VERSION NOTES

- BASE AND BEZEL WERE UNIFIED TO A SINGLE SKU.
- BEZEL FRAME WIDTH WAS REDUCED BY 32% (40mm TO 27mm)
- BASE UNIT SIZE WAS REDUCED - REQUIRED OPENING SIZE REDUCED.

