



Model: WS for TP12 Retrofit Black

Family: WALL-SMART

DWG NO. 10-04-637-SPC

Model No.: 10-01-637

PRODUCT SPEC.

REVISION A

DATE 11/MAY/2016



Make Your Wall Smart

“WS for TP12 Retrofit Black” - Product description:

The “WS for TP12 Retrofit Black” is an adapter for in-wall nearly flush retrofit installation of a TP12 touch screen.

The “WS for TP12 Retrofit Black” securely mounts the TP12 touch screen while allowing easy insertion, removal and operation.

Key features and benefits:

- Nearly flush with the wall (3mm [0.19”] thick on-wall bezel).
- Wall mount may be mounted in any orientation.
- Allows easy insertion and removal of the touch screen.
- Bezel attaches magnetically to the retrofit wall mount base.
- The bezel is supplied painted black, 60% gleam.
- Designed for the use with xTP12 touch screen (by Elan, Niles or Speakercraft) (touch panel is not included).
- Adapter kit contains:
 1. (X1) Wall mount base;
 2. (X1) Bezel;
 3. (X1) TOUCH PANEL ADAPTER;
 4. (X4) M3X12 SCREWS
 5. (X4) M3 NUTS

Key properties:

- Dimensions: (W/H/D): 394.4mm (15.53”)/ 282.3mm (11.11”)/ 41mm (1.66”)
- Weight: 2.2Kg, 4.84lbs.
- Material: Moisture resistant MDF

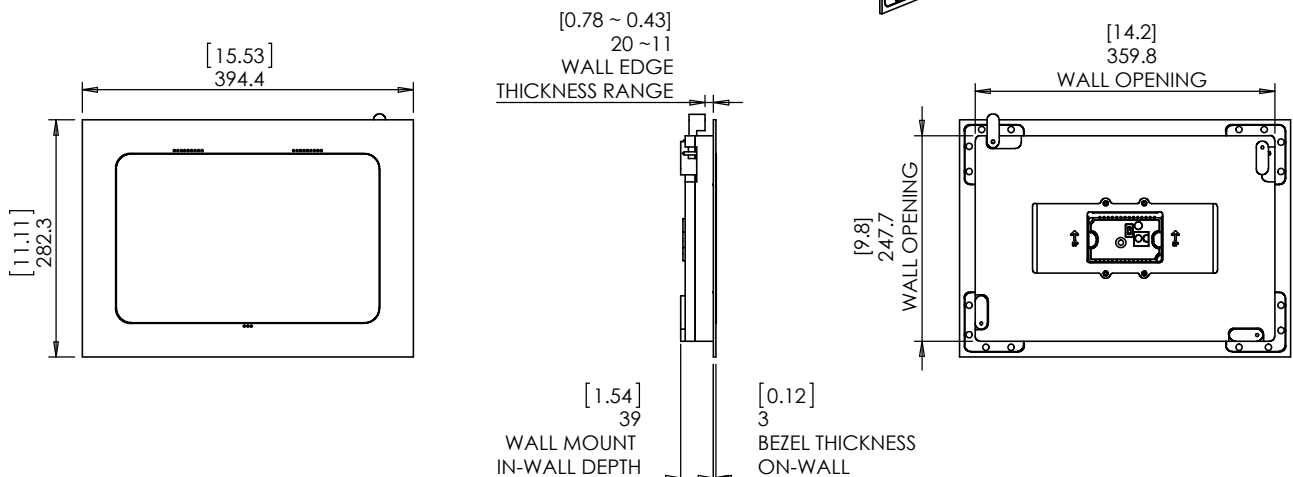
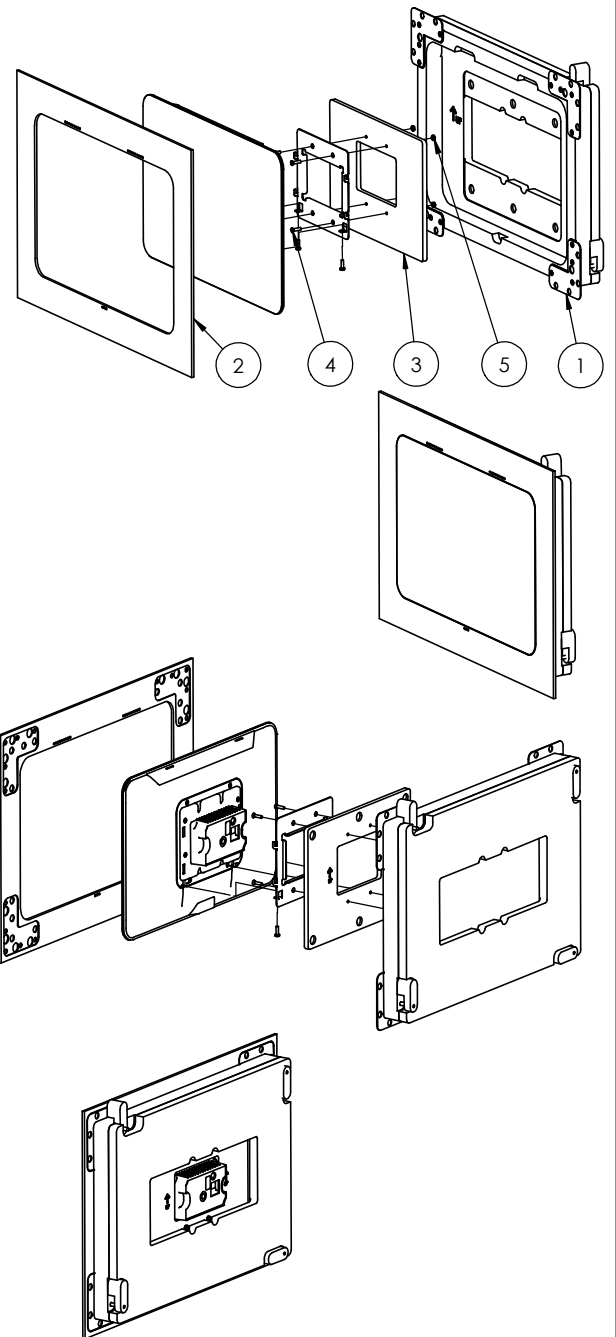

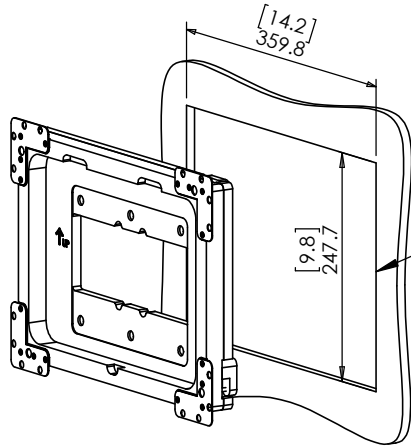

1. CUT OPENING

2. ROUTE NECESSARY CABLES

3. INSERT WALL MOUNT BASE

4. GENTLY SCREW CLOCKWISE 4 RETENTION SCREWS UNTIL CAM LATCHES RETAIN THE UNIT.

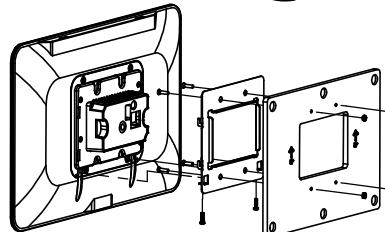
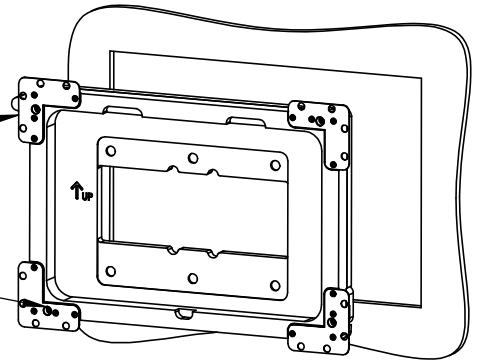
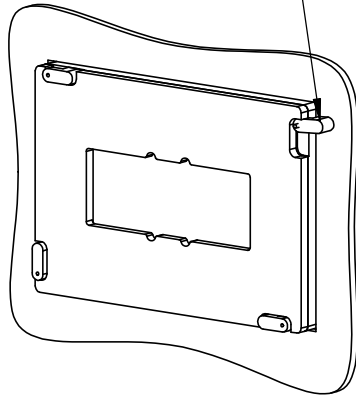

5. ASSEMBLE THE TOUCH PANEL ADAPTOR

6. ATTACH TOUCH SCREEN (MAGNETICALLY)

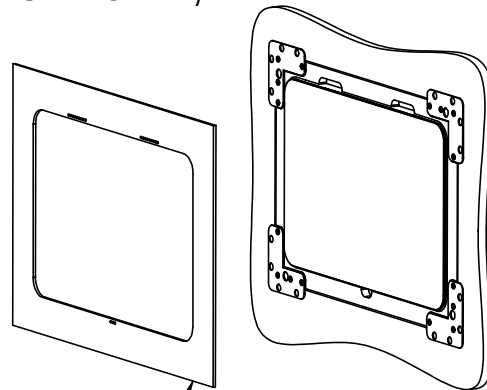
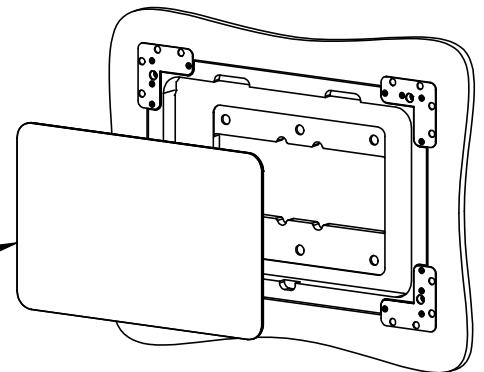

7. ATTACH THE BEZEL (MAGNETICALLY)

